



VM 系列 — 真空發生器

作動規格表與訂購稱呼說明

氣立可空氣壓設備



◀ 內部結構圖

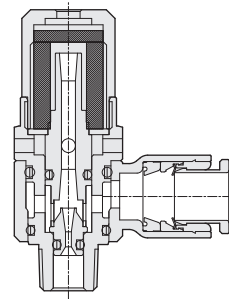

◀ 規格表

項目	機種	VMB、VMD、VML、VMK、VMT
使用流體		空氣
使用壓力範圍	Kgf/cm ² (Kpa)	0~9 (900)
持續壓力	Kgf/cm ² (Kpa)	5 (500)
到達真空度		-91.8 kpa (-690mmHg)
噴嘴直徑	(mm)	0.5mm, 0.7mm, 1.0mm, 1.5mm, 2.0mm
使用溫度範圍	°C	5~60
材質	本體	黃銅 (鍍鎳)
	塑膠	NYLON, PBT, PP
連接口徑	Rc (PT)	M5x0.8p, 1/8"
牙部塗膠		附塗膠

◀ 訂購稱呼代號

VM - **B** - **10** - **6** - **01**

真空發生器 機種仕樣 噴嘴口徑 管徑 牙徑

VMB / D 系列

噴嘴直徑	記號	管徑		
		Ø6	Ø8	Ø10
05	6	●	-	-
07	6	●	-	-
	8	-	●	-
10	6	●	-	-
	8	-	●	-
15	8	-	-	●
	10	-	-	●

管徑	記號	牙徑	
		1/8"	1/4"
Ø6	01	●	-
Ø8	01	●	-
	02	-	●
Ø10	02	-	●

VM - **L** - **10** - **6** - **01** - **C**

真空發生器 機種仕樣 噴嘴口徑 管徑 牙徑 固定架

VML / T / K 系列

噴嘴直徑	記號	管徑				
		Ø4	Ø6	Ø8	Ø10	Ø12
05	4	●	-	-	-	-
6	6	-	●	-	-	-
10	6	-	●	-	-	-
	8	-	-	●	-	-
15	8	-	-	●	-	-
	10	-	-	-	●	-
20	10	-	-	-	●	-
	12	-	-	-	-	●

管徑	記號	牙徑				
		M5	1/8"	1/4"	3/8"	1/2"
Ø4	M5	●	-	-	-	-
Ø6	01	-	●	-	-	-
	02	-	-	●	-	-
Ø8	01	-	●	-	-	-
	02	-	-	●	-	-
Ø10	03	-	-	●	-	-
Ø12	04	-	-	-	●	-

■ 無記號：不附固定架
 □：附固定架 (選配件)

★ VMK 限定規格選項



真空發生器

VMB / VMD 系列

CHELIC PNEUMATIC

◀ VMB 系列

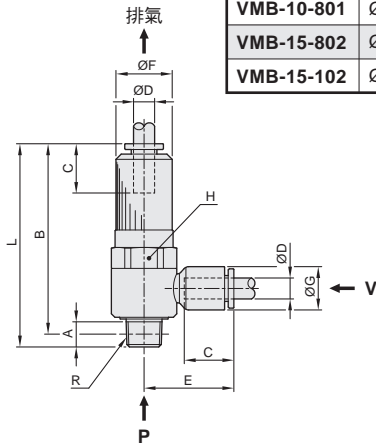

型式	管徑 ØD	牙徑 R	A	B	C	E	ØF	ØG	對邊 H	L	噴嘴直徑 mm	真空流量 L/min ANR	重量 (g)
VMB-05-601	Ø6	1/8"	7.2	54.6	16.7	25.5	16	12.4	17	58.2	0.5	11.5	45
VMB-07-601	Ø6		7.2	54.6	16.7	25.5	16	12.4	17	58.7	0.7	23	45
VMB-07-801	Ø8		7.2	56.2	18.8	27.6	16	14.3	17	59.8	0.7	23	50
VMB-10-601	Ø6		7.2	54.6	16.7	25.5	16	12.4	17	58.2	1.0	45	45
VMB-10-801	Ø8	1/4"	7.2	56.2	18.8	27.6	16	14.3	17	59.8	1.0	45	50
VMB-15-802	Ø8		8	69	18.8	27.6	19	14.3	21	73	1.5	67.5	53
VMB-15-102	Ø10	8	69	21	29.6	19	17.9	21	73	1.5	67.5	53	

EV
真空發生器

EVM
真空控制閥

VA □
真空發生器
真空壓力開關

VM □
真空發生器

VM □ **U**
真空發生器

VK □
模組化
真空發生器

VFD
真空過濾器

VFM
真空過濾器

◀ VMD 系列

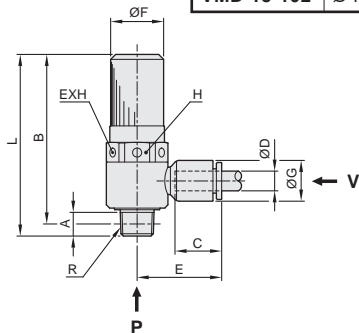

型式	管徑 ØD	牙徑 R	A	B	C	E	ØF	ØG	對邊 H	L	噴嘴直徑 mm	真空流量 L/min ANR	重量 (g)
VMD-05-601	Ø6	1/8"	7.2	45	16.7	25.5	16	12.4	17	48.6	0.5	11.5	45
VMD-07-601	Ø6		7.2	45	16.7	25.5	16	12.4	17	48.6	0.7	23	45
VMD-07-801	Ø8		7.2	45	18.8	27.6	16	14.3	17	48.6	0.7	23	50
VMD-10-601	Ø6		7.2	45	16.7	25.5	16	12.4	17	48.6	1.0	45	45
VMD-10-801	Ø8	1/4"	7.2	45	18.8	27.6	16	14.3	17	48.6	1.0	45	50
VMD-15-802	Ø8		8	54	18.8	27.6	19	14.3	21	58	1.5	67.5	53
VMD-15-102	Ø10	8	54	21	29.6	19	17.9	21	58	1.5	67.5	53	

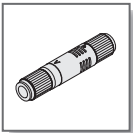

VML, VMK 系列 — 真空發生器

外觀圖形尺寸

氣立可空氣壓設備

◉ VML 系列



型式	管徑 ØD	C	ØG	L	ØP	噴嘴直徑 mm	真空流量 L/min ANR	重量 (g)
VML-05-04	Ø 4	14.1	13	60	14.3	0.5	11.5	25
VML-05-06	Ø 6	17.1	13	65.9	14.3	0.5	11.5	25
VML-10-06	Ø 6	17.1	15	75.6	15.8	1.0	45	30
VML-10-08	Ø 8	18.7	15	78.5	15.8	1.0	45	30
VML-15-08	Ø 8	19.7	18	79.6	18.8	1.5	67.5	45
VML-15-10	Ø 10	19.7	18	79.6	18.8	1.5	67.5	45
VML-20-10	Ø 10	21	21	90.2	21.8	2.0	90	53
VML-20-12	Ø 12	21	21	90.2	21.8	2.0	90	53

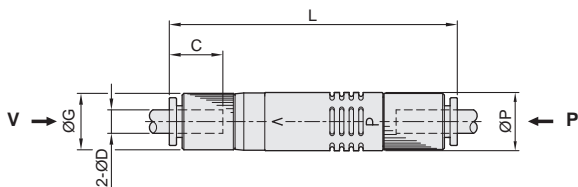

◉ VMK 系列



型式	管徑 ØD	牙徑 R	A	B	C	ØG	對邊 H	L	ØP	噴嘴直徑 mm	真空流量 L/min ANR	重量 (g)
VMK-05-4M5	Ø 4	M5x0.8p	3.1	55	14.1	13	12	56.4	14.3	0.5	11.5	20
VMK-05-601	Ø 6	PT 1/8"	6	59.6	17.1	13	12	62.6	14.3	0.5	11.5	25
VMK-10-601	Ø 6	PT 1/8"	6	70.4	17.1	15	14	73.4	15.8	1.0	45	30
VMK-10-801	Ø 8		6	72	18.7	15	14	75	15.8	1.0	45	30
VMK-15-802	Ø 8	PT 1/4"	8	69.9	18.7	18	17	74.3	18.8	1.5	67.5	45
VMK-15-103	Ø 10	PT 3/8"	8	69.9	19.7	18	17	74.3	18.8	1.5	67.5	45
VMK-20-103	Ø 10	PT 3/8"	10	83.5	19.7	21	21	89	21.8	2.0	90	53
VMK-20-124	Ø 12	PT 1/2"	10	83.5	21	21	21	89	21.8	2.0	90	53

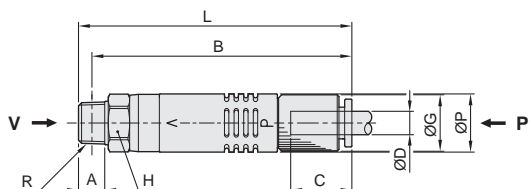

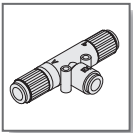

VMT 系列 — 真空發生器

外觀圖形尺寸

CHELIC PNEUMATIC

◀ VMT 系列



型式	管徑 ØD1	管徑 ØD2	C1	C2	E1	E2	F1	F2	ØG1	ØG2	L	噴嘴直徑 mm	真空流量 L/min ANR	重量 (g)
VMT-05-04	Ø4	Ø6	14.1	17.1	23.8	29.1	8.7	15	13	12.4	60	0.5	11.5	40
VMT-05-06	Ø6		17.1		23.8	32.1	8.7	15	13	12.4	65.9	0.5	11.5	40
VMT-10-06	Ø6	Ø8	17.1	18.7	27.3	40.3	9.7	15	15	14.3	75.6	1.0	45	45
VMT-10-08	Ø8		18.7		27.3	41.9	9.7	15	15	14.3	78.5	1.0	45	35
VMT-15-08	Ø8	Ø10	18.7	20.9	42	39.8	11.2	21.3	18	17.8	79.6	1.5	67.5	58
VMT-15-10	Ø10		18.7		42	39.8	11.2	21.3	18	17.8	79.6	1.5	67.5	54
VMT-20-10	Ø10	Ø12	18.7	23.8	50	45.1	12.7	24.6	21	21.1	90.2	2.0	90	69
VMT-20-12	Ø12		18.7		50	45.1	12.7	24.6	21	21.1	90.2	2.0	90	64

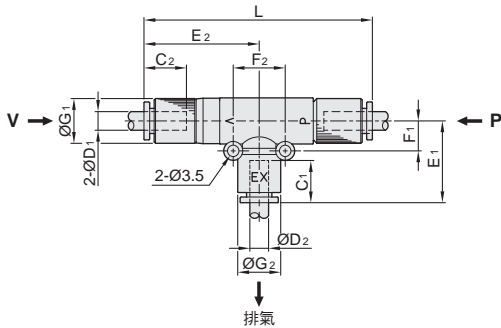

EV
真空發生器

EVM
真空控制閥

VA □
真空發生器
真空壓力開關

VM □
真空發生器

VM □ **U**
真空發生器

VK □
橫組化
真空發生器

VFD
真空過濾器

VFM
真空過濾器

◀ 固定架安裝方式及參考尺寸

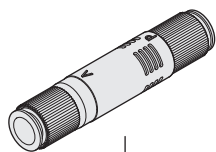

真空發生器

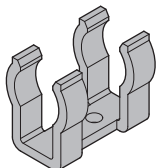

固定架

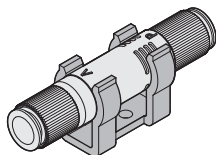

示意圖

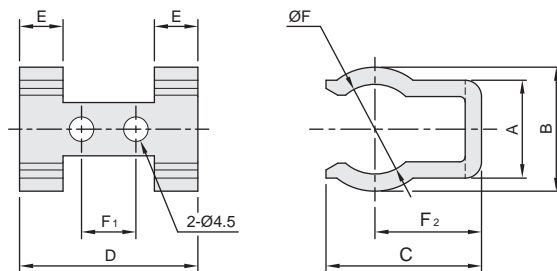

真空發生器 規格	固定架 規格	A	B	C	D	E	ØF	F1	F2
VM □ -05	VM-C01	15	18.5	28.6	32.8	5.7	12.5	10	19.6
VM □ -10	VM-C01								
VM □ -15	VM-C02	18	21	28.6	32.8	8	16.5	10	19.6
VM □ -20	VM-C03	19.6	23.9	34.8	39.4	10	20.4	14	23.8

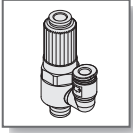

VMBU , VMDU 系列 — 真空發生器

作動規格表與訂購稱呼說明

氣立可空氣壓設備

◎ 內部結構圖

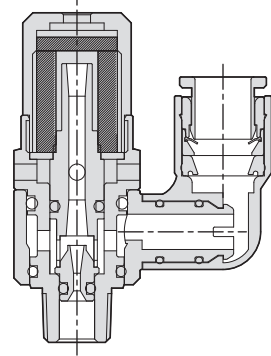

◎ 規格表

項目	機種	VMBU、VMDU
使用流體		空氣
使用壓力範圍	Kgf/cm ² (Kpa)	0~9 (900)
持續壓力	Kgf/cm ² (Kpa)	10 (1000)
到達真空度		-91.8 kpa (-690mmHg)
噴嘴直徑	(mm)	0.5mm , 0.7mm , 1.0mm , 1.5mm , 2.0mm
使用溫度範圍	°C	5 ~ 60
材質	本體	黃銅 (鍍鎳)
	塑膠	NYLON , PBT , PP
連接口徑	Rc (PT)	M5x0.8p , 1/8"
牙部塗膠		附塗膠

◎ 訂購稱呼代號

VMBU	10	6	01																																																														
機種仕樣	噴嘴口徑	管徑	牙徑																																																														
 VMBU	VMBU/VMDU 系列 05 - 0.5 mm 07 - 0.7 mm 10 - 1.0 mm 15 - 1.5 mm	<table border="1"> <thead> <tr> <th rowspan="2">噴嘴直徑</th> <th rowspan="2">記號</th> <th colspan="3">管徑</th> </tr> <tr> <th>Ø6</th> <th>Ø8</th> <th>Ø10</th> </tr> </thead> <tbody> <tr> <td rowspan="2">05</td> <td>6</td> <td>●</td> <td>-</td> <td>-</td> </tr> <tr> <td>8</td> <td>-</td> <td>●</td> <td>-</td> </tr> <tr> <td rowspan="2">10</td> <td>6</td> <td>●</td> <td>-</td> <td>-</td> </tr> <tr> <td>8</td> <td>-</td> <td>●</td> <td>-</td> </tr> <tr> <td rowspan="2">15</td> <td>8</td> <td>-</td> <td>●</td> <td>-</td> </tr> <tr> <td>10</td> <td>-</td> <td>-</td> <td>●</td> </tr> </tbody> </table>	噴嘴直徑	記號	管徑			Ø6	Ø8	Ø10	05	6	●	-	-	8	-	●	-	10	6	●	-	-	8	-	●	-	15	8	-	●	-	10	-	-	●	<table border="1"> <thead> <tr> <th rowspan="2">管徑</th> <th rowspan="2">記號</th> <th colspan="2">牙徑</th> </tr> <tr> <th>1/8"</th> <th>1/4"</th> </tr> </thead> <tbody> <tr> <td rowspan="2">Ø6</td> <td>01</td> <td>●</td> <td>-</td> </tr> <tr> <td>02</td> <td>-</td> <td>●</td> </tr> <tr> <td rowspan="2">Ø8</td> <td>01</td> <td>●</td> <td>-</td> </tr> <tr> <td>02</td> <td>-</td> <td>●</td> </tr> <tr> <td rowspan="2">Ø10</td> <td>01</td> <td>-</td> <td>●</td> </tr> <tr> <td>02</td> <td>-</td> <td>●</td> </tr> </tbody> </table>	管徑	記號	牙徑		1/8"	1/4"	Ø6	01	●	-	02	-	●	Ø8	01	●	-	02	-	●	Ø10	01	-	●	02	-	●
噴嘴直徑	記號	管徑																																																															
		Ø6	Ø8	Ø10																																																													
05	6	●	-	-																																																													
	8	-	●	-																																																													
10	6	●	-	-																																																													
	8	-	●	-																																																													
15	8	-	●	-																																																													
	10	-	-	●																																																													
管徑	記號	牙徑																																																															
		1/8"	1/4"																																																														
Ø6	01	●	-																																																														
	02	-	●																																																														
Ø8	01	●	-																																																														
	02	-	●																																																														
Ø10	01	-	●																																																														
	02	-	●																																																														
 VMDU																																																																	

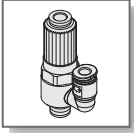

VMBU, VMDU 系列 — 真空發生器

外觀圖形尺寸

CHELIC PNEUMATIC

◀ VMBU 系列

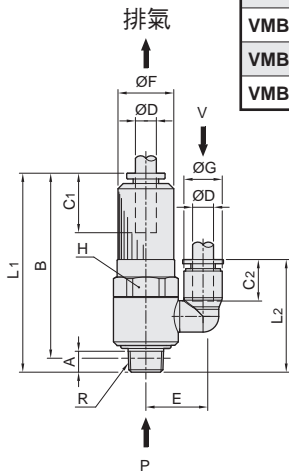

型式	管徑 ØD	牙徑 R	A	B	C1	C2	E	ØF	ØG	L1	L2	對邊 H	噴嘴 直徑 mm	真空 流量 L/min ANR	重量 (g)
VMBU-05-601	Ø6	1/8"	6	53	16.5	11.5	16.4	16	11	57	32.3	17	0.5	11.5	45
VMBU-07-601	Ø6		6	53	16.5	11.5	16.4	16	11	57	32.3	17	0.7	23	45
VMBU-07-801	Ø8		6	53.3	18.2	17	21.5	16	14.3	57.3	38.3	17	0.7	23	50
VMBU-10-601	Ø6		6	53	16.5	11.5	16.4	16	11	57	32.3	17	1.0	45	45
VMBU-10-801	Ø8	1/4"	6	53.3	18.2	17	21.5	16	14.3	57.3	38.3	17	1.0	45	50
VMBU-15-802	Ø8		10	69	18.2	17	23.7	21	14.3	76	45.1	21	1.5	67.5	53
VMBU-15-102	Ø10		10	69.3	20	20	26	21	17.8	76.3	48.9	21	1.5	67.5	53

EV
真空發生器

EVM
真空控制閥

VA □
真空發生器
真空壓力開關

VM □
真空發生器

VM □ **U**
真空發生器

VK □
模組化
真空發生器

VFD
真空過濾器

VFM
真空過濾器

◀ VMDU 系列

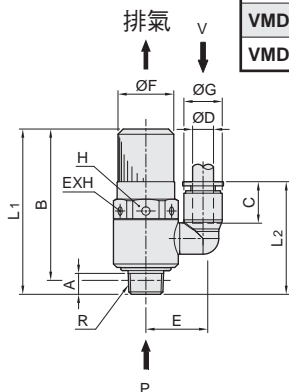

型式	管徑 ØD	牙徑 R	A	B	C	E	ØF	ØG	L1	L2	對邊 H	噴嘴 直徑 mm	真空 流量 L/min ANR	重量 (g)
VMDU-05-601	Ø6	1/8"	6	43.4	11.5	25.5	16	11	47.4	32.3	17	0.5	11.5	45
VMDU-07-601	Ø6		6	43.4	11.5	25.5	16	11	47.4	32.3	17	0.7	23	45
VMDU-07-801	Ø8		6	43.4	17	27.6	16	14.3	47.4	38.3	17	0.7	23	50
VMDU-10-601	Ø6		6	43.4	11.5	25.5	16	11	47.4	32.3	17	1.0	45	45
VMDU-10-801	Ø8	1/4"	6	43.4	17	27.6	16	14.3	47.4	38.3	17	1.0	45	50
VMDU-15-802	Ø8		10	64.1	17	27.6	21	14.3	71.1	45.1	21	1.5	67.5	53
VMDU-15-102	Ø10		10	64.1	20	29.6	21	17.8	71.1	48.9	21	1.5	67.5	53

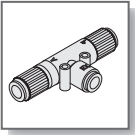

真空發生器

使用範例

氣立可空氣壓設備

► 使用範例

(a)

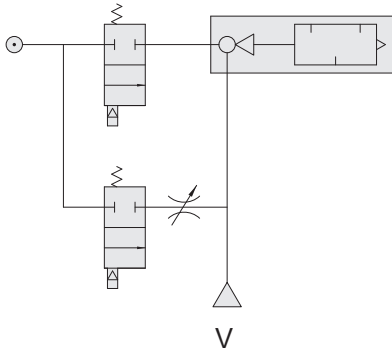

● 搭配2口2位電磁閥之使用範例。

(b)

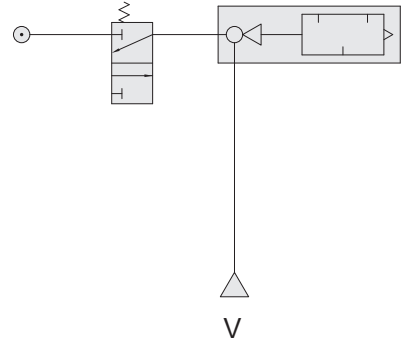

● 搭配3口2位電磁閥之使用範例。

(c)

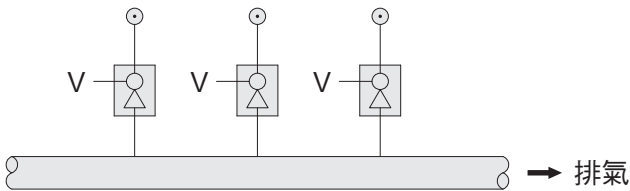

● 集中排氣(VMB及VMT系列)之使用範例。